

Vectron International

Filter specification

TFS 110AA

1/5

Measurement condition

Ambient temperature: 23 °C
 Input power level: 0 dBm
 Terminating impedance: *
 Input: 939 Ω || -12,09 pF
 Output: 809 Ω || -11,79 pF

Characteristics

Remark:

The nominal frequency f_N is fixed at 110,6 MHz. The insertion loss a_e is defined as loss value determined at f_N . Reference level for the relative attenuation a_{rel} of the TFS 110AA is the insertion loss a_e . The centre frequency f_C is the arithmetic mean value of the upper and lower frequencies at the 3 dB filter attenuation level relative to the insertion loss a_e . All specified data are met within the operating temperature range.

D a t a		typ. value		tolerance / limit		
Insertion loss (reference level)	a_e	7,0	dB	max.	9,5	dB
Nominal frequency	f_N	-			110,6	MHz
Centre frequency	f_C	110,6	MHz		-	
Passband	PB	-		$f_N \pm$	0,1	MHz
Amplitude ripple within PB		1,5	dB	max.	3	dB
Relative attenuation	a_{rel}					
f_N ... $f_N \pm 0,1$ MHz		1,5	dB	max.	3	dB
$f_N \pm 0,5$ MHz ... $f_N \pm 6$ MHz		38	dB	min.	33	dB
$f_N \pm 6$ MHz ... $f_N \pm 10$ MHz		47	dB	min.	40	dB
Group delay ripple within PB	p-p	300	ns	max.	700	ns
Operating temperature range	OTR	-		- 20 °C ... + 70 °C		
Storage temperature range		-		- 40 °C ... + 85 °C		
Frequency inversion temperature		-		-		
Temperature coefficient of frequency	TC_f **	-0,04	ppm/K ²		-	

*) The terminating impedances depend on parasitics and q-values of matching elements and the board used, and are to be understood as reference values only. Should there be additional questions do not hesitate to ask for an application note or contact our design team.

***) $\Delta f(\text{Hz}) = TC_f(\text{ppm/K}^2) \times (T-T_0)^2 \times f_{cat}(\text{MHz})$.

Generated:

Checked / Approved:

Vectron International GmbH & Co. KG
Potsdamer Straße 18
D 14 513 TELTOW / Germany
Tel: (+49) 3328 4784-0 / Fax: (+49) 3328 4784-30
E-Mail: fft@vectron.com

Vectron International GmbH & Co. KG reserves the right to make changes to the product(s) and/or information contained herein without notice. No liability is assumed as a result of their use or application. No rights under any patent accompany the sale of any such product(s) or information.

Filter characteristic

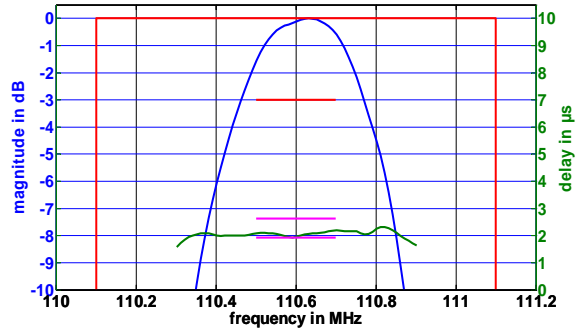
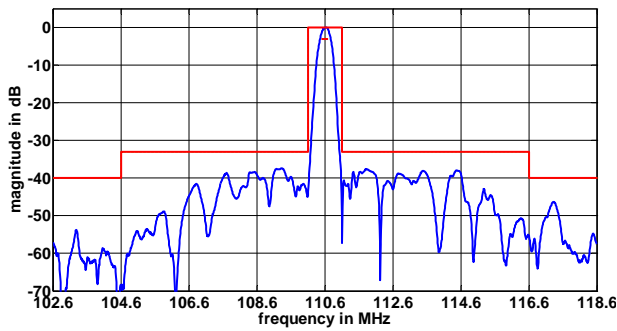

Construction and pin connection

(All dimensions in mm)

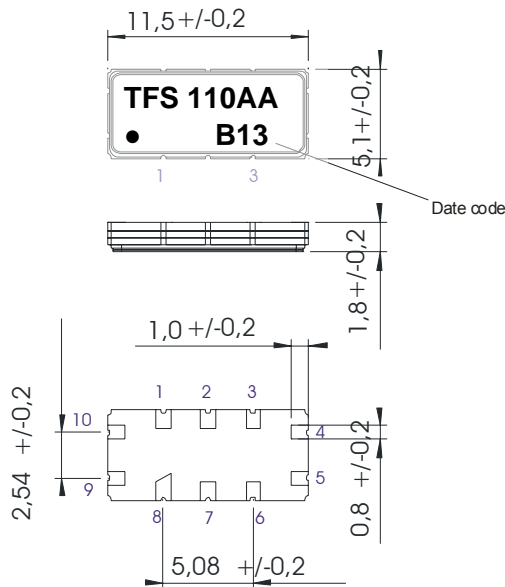

- 1 Ground
- 2 Ground
- 3 Ground
- 4 Output
- 5 Output RF Return
- 6 Ground
- 7 Ground
- 8 Ground
- 9 Input
- 10 Input RF Return

Date code: Year + week
 A 2010
 B 2011
 C 2012
 ...

50 Ohm Test circuit

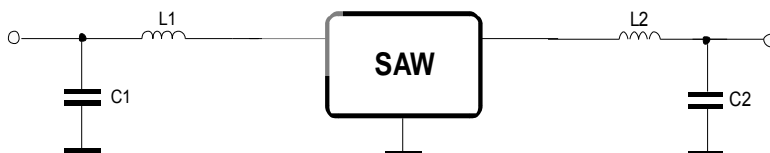

Vectron International GmbH & Co. KG
 Potsdamer Straße 18
 D 14 513 TELTOW / Germany
 Tel: (+49) 3328 4784-0 / Fax: (+49) 3328 4784-30
 E-Mail: fft@vectron.com

VECTRON reserves the right to make changes to the product(s) and/or information contained herein without notice. No liability is assumed as a result of their use or application. No rights under any patent accompany the sale of any such product(s) or information.

Stability characteristics, reliability

After the following tests the filter shall meet the whole specification:

1. Shock: 500g, 1 ms, half sine wave, 3 shocks each plane;
DIN IEC 68 T2 - 27
2. Vibration: 10 Hz to 500 Hz, 0,35 mm or 5 g respectively, 1 octave per min, 10 cycles per plan, 3 plans;
DIN IEC 68 T2 - 6
3. Change of temperature: -55 °C to 125°C / 30 min. each / 10 cycles
DIN IEC 68 part 2 – 14 Test N
4. Resistance to solder heat (reflow): reflow possible: three times max.;
for temperature conditions refer to the attached "Air reflow temperature conditions" on page 4;
5. ESD ANSI/ESD S20.20-1999, class 1A for HBM

This filter is RoHS compliant (2002/95/EG, 2005/618/EG)

Packing

Tape & Reel: IEC 286 – 3, with exception of value for N and minimum bending radius;
tape type II, embossed carrier tape with top cover tape on the upper side;

max. pieces of filters per reel:	3000
reel of empty components at start:	min. 300 mm
reel of empty components at start including leader:	min. 500 mm
trailer:	min. 300 mm

Tape (all dimensions in mm)

- W : 24± 0,3
- Po : 4 ± 0,1
- Do : 1,5 + 0,1
- E : 1,75 ± 0,1
- F : 11,5 ± 0,1
- G (min) : 0,6
- P2 : 2 ± 0,1
- P1 : 8 ± 0,1
- D1(min) : 1,5
- Ao : 5,5 ± 0,1
- Bo : 11,9 ± 0,1
- CT : 21,5 ± 0,1

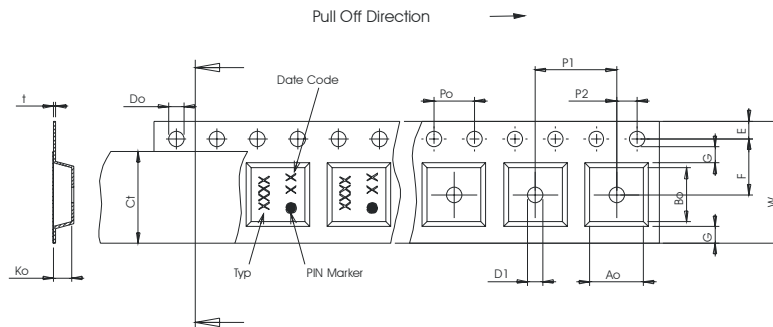

Reel (all dimensions in mm):

- A : 330
- W1 : 24,4 +2
- W2 (max) : 30,4
- N (min) : 60
- C : 13 +0,5/-0,2

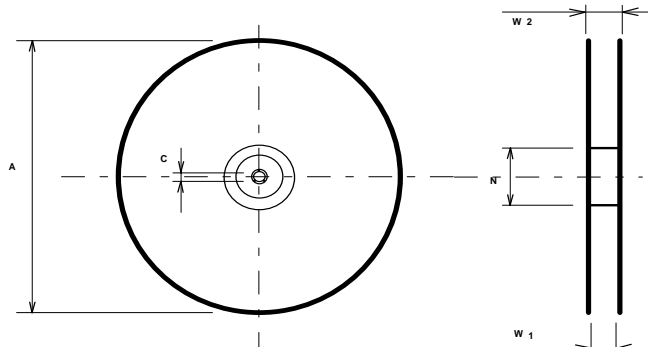

The minimum bending radius is 45 mm.

Vectron International GmbH & Co. KG
Potsdamer Straße 18
D 14 513 TELTOW / Germany
Tel: (+49) 3328 4784-0 / Fax: (+49) 3328 4784-30
E-Mail: tf@vectron.com

VECTRON reserves the right to make changes to the product(s) and/or information contained herein without notice. No liability is assumed as a result of their use or application. No rights under any patent accompany the sale of any such product(s) or information.

Air reflow temperature conditions

Conditions	Exposure
Average ramp-up rate (30°C to 217°C)	less than 3°C/second
> 100°C	between 300 and 600 seconds
> 150°C	between 240 and 500 seconds
> 217°C	between 30 and 150 seconds
Peak temperature	max. 260°C
Time within 5°C of actual peak temperature	between 10 and 30 seconds
Cool-down rate (Peak to 50°C)	less than 6°C/second
Time from 30°C to Peak temperature	no greater than 300 seconds

Chip-mount air reflow profile

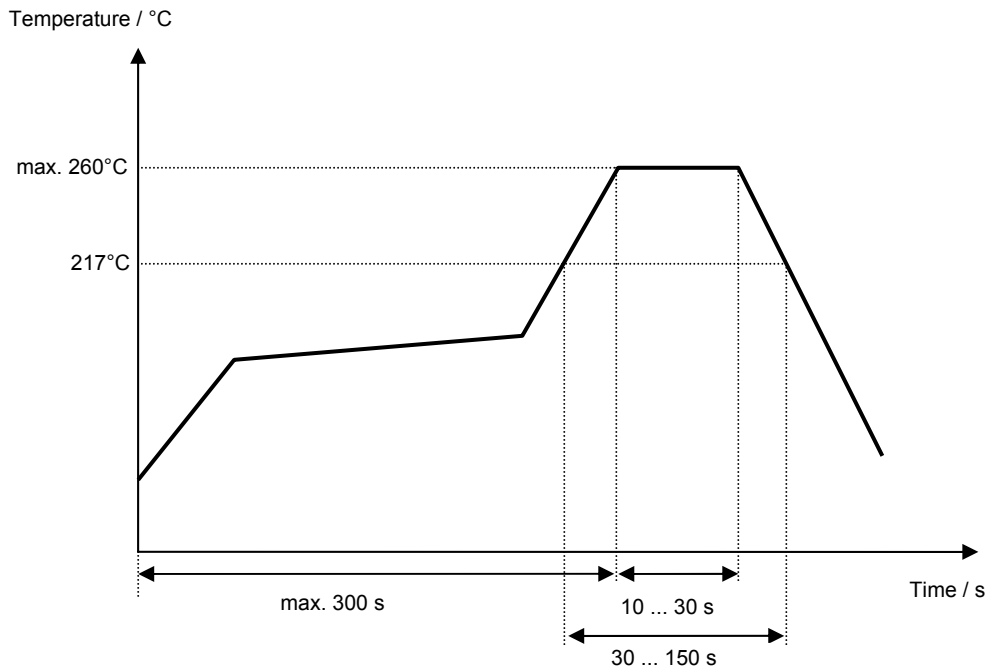

History

Version	Reason of Changes	Name	Date
1.0	- Development specification	Pfeiffer	04.02.2010
1.1	- Changed centre freq. from 110.592 to 110.6MHz	A. Hodkin	21.04.2010
1.2	- Change from development spec to filter spec - Typical values added - Filter characteristic added	Molke	22.03.2011